

日期/Date
档案员
Filing Clerk

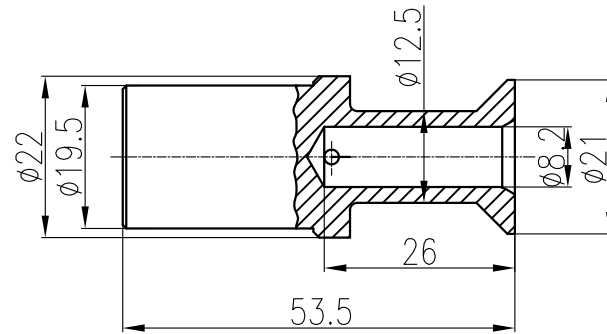

技术参数:

- 材料: 铜合金
- 表面处理: 镀银
- 额定电流: 350A
- 接触电阻: $\leq 0.3m\Omega$
- 线径范围: $35mm^2$
- 剥线长度: 26mm
- 最大电缆直径: 22mm
- 冷压模具: 按照 DIN 46 235
- 压力要求: 130kN
- 可插拔次数: ≥ 500

Technical specification:

- Material: copper alloy
- Surface: hard-silver plated
- Rated current: 350A
- Contact resistance: $\leq 0.3m\Omega$
- Wire gauge: $35mm^2$
- Stripping length: 26mm
- Max. insulation diameter: 22mm
- Crimp dies: acc. to DIN 46 235
- Pressing force: 130kN
- Mating cycles: ≥ 500

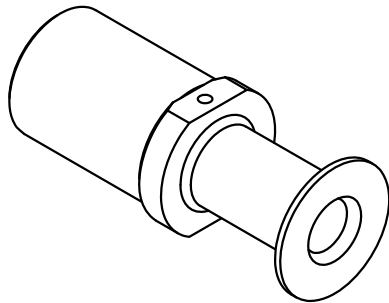

						表面处理 Finish		-		图号 Drawing No.		-	
						材料 Material		-		产品代号 Part Code		CHSF350-35G	
标记 Mark		处数 Number		变更描述/Description		签名 Signature		日期 Date		产品料号 Part No.		1010291201703	
		姓名/Name		日期/Date		姓名/Name		日期/Date		比例 Scale		版本 REV.	
绘图 Drawn		BQ LUO		18.10.2010		标准化 Stand.		-		重量 Weight		86.5g	
审核 Checked		P RAO		18.10.2010						数量 Qty.		-	
工艺 Process		-		-		批准 Approved		YY LIN 18.10.2010		All Dimensions in mm Original Size DIN A 4		厦门唯恩电气有限公司 XIAMEN WAIN ELECTRICAL CO.LTD	