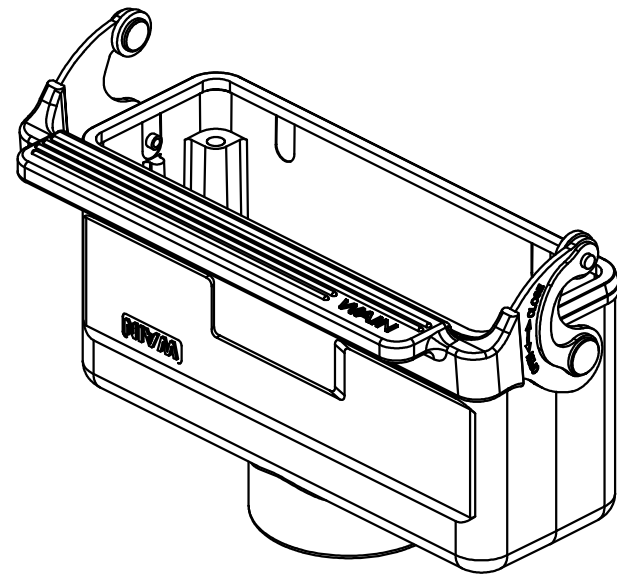
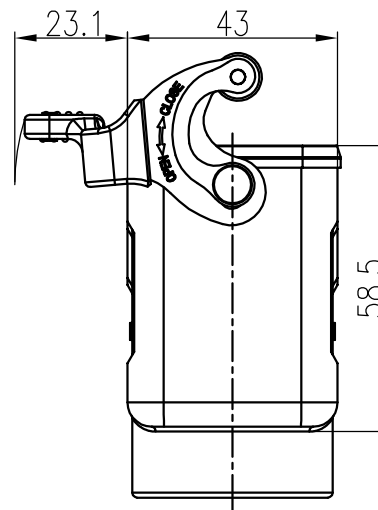
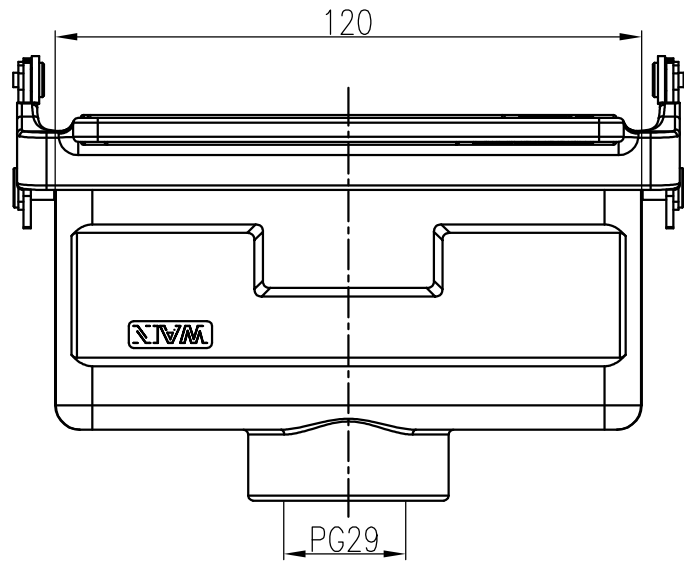

日期/Date

档案员
Filing Clerk

技术参数:

- 材料: 压铸铝
- 表面处理: 粉末喷涂
- 颜色: RAL 7037 (灰色)
- 温度范围: -40°C - $+125^{\circ}\text{C}$
- 防护等级: IP67 (联锁状态, IEC 60529)
- 联锁元件:
 - 锁扣方式: 金属单扣
 - 材料: 不锈钢+软胶
- 密封元件: NBR
- 出线方向: 顶出线
- 出线孔数: 1
- 螺纹规格: PG29

Technical specification:

- Material: aluminium die-cast
- Surface: powder-coated
- Colour: RAL 7037(grey)
- Temperature range: -40°C - $+125^{\circ}\text{C}$
- Degree of protection: IP67
(acc.to IEC 60529 for coupled connector)
- Locking element:
 - Locking type: single locking latch
 - material: stainless steel+TPR
- Hoods/Housings sealing: NBR
- Cable entry: top entry
- No. of cable entries: 1
- Thread size: PG29

						表面处理 Finish	-		图号 Drawing No.	-
						材料 Material	-		产品代号 Part Code	W24B-CCT-1L/SC-PG29
标记 Mark	处数 Number	变更描述/Description		签名 Signature	日期 Date				产品料号 Part No.	1111247211004
绘图 Drawn	姓名/Name	日期/Date	标准化 Stand.	姓名/Name	日期/Date	比例 Scale	版本 REV.	重量 Weight	数量 Qty.	产品名称 Part Name
审核 Checked	SY JI	18.10.2017		-	-	2:3	V1.0	-	-	-
工艺 Process	-	-	批准 Approved	YY LUO	18.10.2017	 		All Dimensions in mm Original Size DIN A 4		 厦门唯恩电气有限公司 XIAMEN WAIN ELECTRICAL CO.LTD