

日期/Date	档案员 Filing Clerk	1		2		3		4		5		6	
产品代号 Part Code	产品料号 Part NO.	A	B	C	D	E	F	G	重量/Weight g				
CC6B-BK	1980020080005	70	44	32	87.3	64.4	125	55	76				
CC10B-BK	1980020080006	83	57	32	87.3	64.4	125	55	76				
CC16B-BK	1980020080007	103	77.5	32	87.3	64.4	125	55	76				
CC24B-BK	1980020080008	130	104	32	87.8	64.4	150	54.5	76				

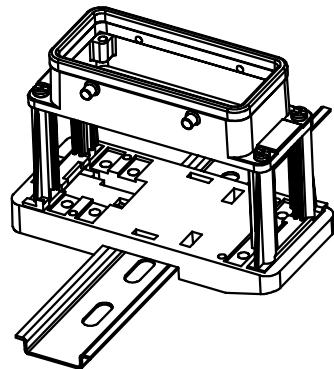
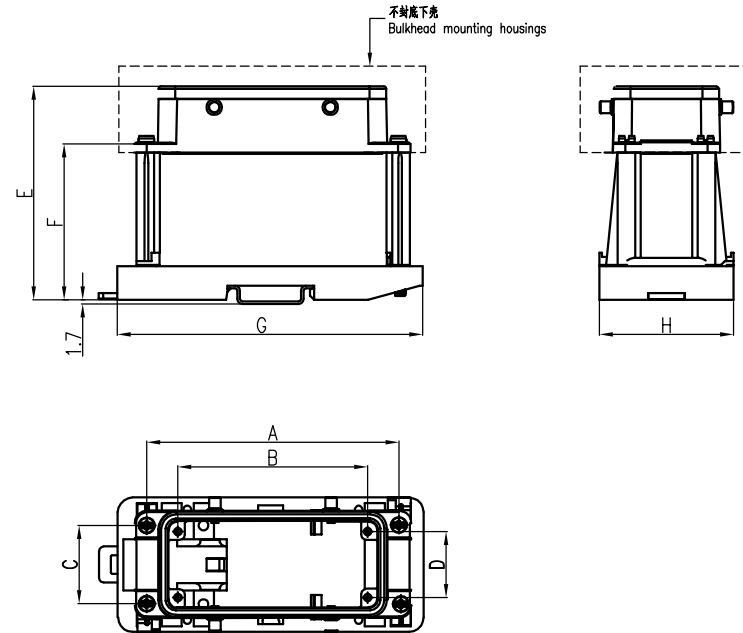

技术参数:

- 材料: 聚碳酸酯

Technical specification:

- Material: polycarbonate

						表面处理 Finish	-			图号 Drawing No.	-
						材料 Material	-			产品代号 Part Code	CCXXB-BK
标记 Mark	处数 Number	变更描述/Description			签名 Signature		日期 Date				产品料号 Part No.
	姓名/Name	日期/Date		姓名/Name	日期/Date	比例 Scale	版本 REV.	重量 Weight	数量 Qty.	产品名称 Part Name	-
绘图 Drawn	BQ LUO	18.10.2010	标准化 Stand.	-	-	1:3	V1.0	141g	-		
审核 Checked	P RAO	18.10.2010									
工艺 Process	-	-	批准 Approved	YY LIN	18.10.2010			All Dimensions in mm Original Size DIN A 4			厦门唯恩电气有限公司 XIAMEN WAIN ELECTRICAL CO.LTD